

Product Description

The **IP1500/IP1501** is a full duplex VoIP speakerphone that provides a reliable and direct communication with first responders. Available in either flush and surface mounts, its compact size and SIP capabilities make it ideal for a wide range of indoor and outdoor locations, like hallways, stairwells, classrooms, subway cars, parking garages, elevators and door entries.

Standard Features

- ✓ Full duplex
- ✓ PoE power
- ✓ Self-monitoring
- ✓ Proprietary screws for vandal resistance
- ✓ Piezoelectric buttons that won't stick or jam



Popular Upgrades



ToolVox™ XV
Virtual Machine



ToolVox™ XS
Server



Managed Cloud Solutions



Remote Mounted
Strobe



Hearing Loop

Available Configurations



Surface Mounted
(IP1500)



Flush Mounted
(IP1501)



Available in Stainless Steel or Painted finishes.

Technical Features



Specifications

- **Dimensions:**
 - **Surface:** 4.56" W x 4.56" H x 2.18"D (11.58 x 11.58 x 5.54cm)
 - **Flush:** 5.75" W x 5.38" H x 2.39" D (14.6 x 13.6 x 6.07cm)
- **Weight:**
 - **IP1500:** 1.53 lbs (0.69kg)
 - **IP1501:** 1.75 lbs (0.79kg)
- **Contact Closures-OUT:** 1
- **Ethernet Ports:** 1
- **Power:** PoE
- **RAM:** 1MB
- **Operational Temperature:** -40°C to 70° C (-40° F to 158° F)

Mounting

- Flush (IP1500)
- Surface (IP1501)

Faceplate

- Piezoelectric data button
- ADA Braille bezel
- Conformal coated PCB
- 1 LED status indicator light

Style

- Standard Bezel Text: Push For Help, Emergency
- Custom Options Available

Compliance



- UL 62368-1

IP1500 Surface Mount

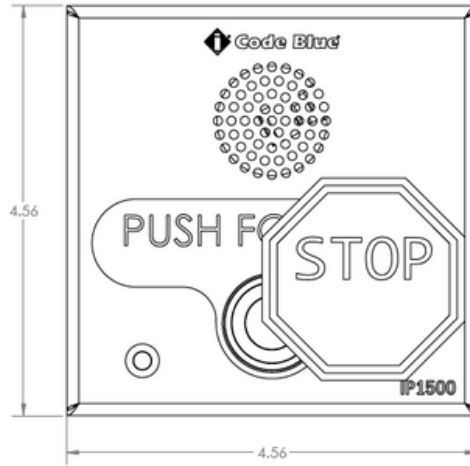

FRONT VIEW

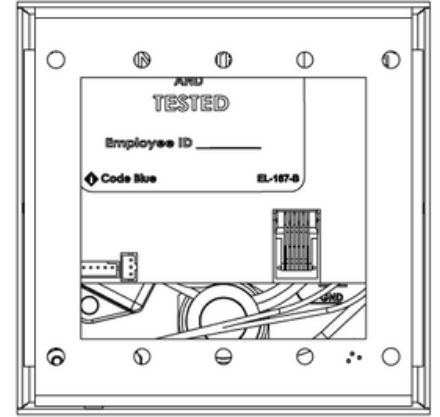

REAR VIEW

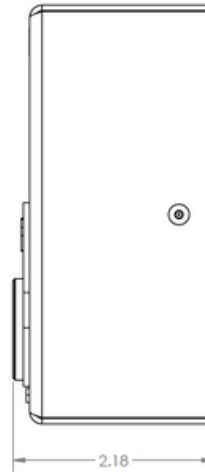

SIDE VIEW

IP1501 Flush Mount

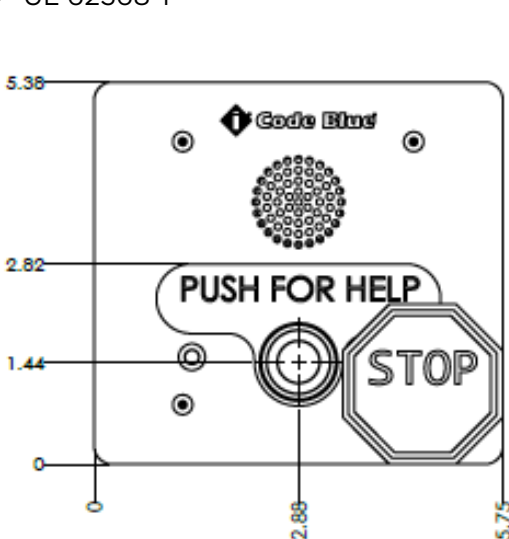

FRONT VIEW

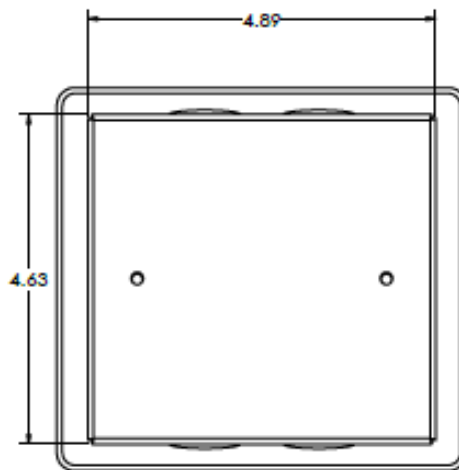

REAR VIEW

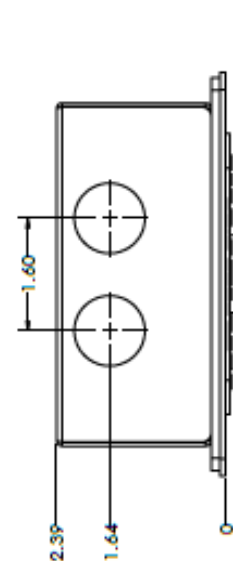

BOTTOM VIEW

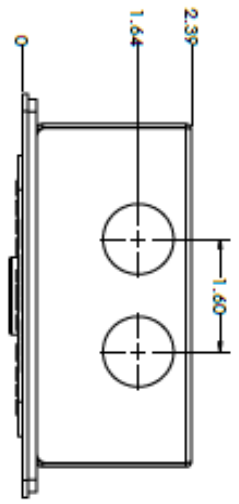

TOP VIEW

Note: Specifications subject to change without notice or obligation on the part of Code Blue Corporation.